





**Assembled POF
Cables/组装POF光
缆**



F-05塑料光纤跳线（POF） F-05 Patch cord for Plastic Optical Fiber (POF)		
简图/Dimension	描述 / Description	Art.-No.
	Toslink Gold plug with single lock, simplex with 2.2mm PE POF black cable Toslink 金属头单锁片,单工2.2mm PE POF黑色光缆	KINZ-PC-F05001
	Toslink Gold plug with single lock, simplex with 4.0mm PE POF black cable Toslink 金属头单锁片,单工4.0mm PE POF黑色光缆	KINZ-PC-F05002
	Toslink plastic plug with double lock, simplex with 2.2mm PE POF black cable (Pink/Black/White connector) Toslink 塑料头双锁片,单工2.2mm PE POF黑色光缆（粉色/黑色/白色连接 器）	KINZ-PC-F05003
	Toslink Gold plug with double lock, simplex with 2.2mm PE POF black cable Toslink 金属头头双锁片,单工2.2mm PE POF黑色光缆	KINZ-PC-F05004

*POF=Polymer fiber/*POF=聚合物光纤

All patch cord with dust cap/所有跳线带防尘帽

Can be further customized according to the requirements/可根据要求进行进一步定制

**Assembled POF
Cables/组装POF光
缆**



F-05塑料光纤跳线 (POF) F-05 Patch cord for Plastic Optical Fiber (POF)		
简图/Dimension	描述 / Description	Art.-No.
	Toslink-Mini Gold plug with single lock, simplex with 2.2mm PE POF black cable Toslink-Mini 金属头单锁片,单工2.2mm PE POF黑色光缆	KINZ-PC-F05005
	Toslink-Mini Gold plug with double lock, simplex with 2.2mm PE POF black cable Toslink-Mini 金属头双锁片,单工2.2mm PE POF黑色光缆	KINZ-PC-F05006
	Mini-Mini Gold plug with single lock, simplex with 2.2mm PE POF black cable (black/white connector) Mini-Mini金属头单锁片,单工2.2mm PE POF黑色光缆 (黑色/白色连接器)	KINZ-PC-F05007
	Toslink Gold plug , simplex with 3.8mm PE POF black cable Toslink 金属头,单工3.8mm PE POF黑色光缆	KINZ-PC-F05008

*POF=Polymer fiber/*POF=聚合物光纤

All patch cord with dust cap/所有跳线带防尘帽

Can be further customized according to the requirements/可根据要求进行进一步定制

**Assembled POF
Cables/组装POF光
缆**

F-05塑料光纤跳线 (POF) F-05 Patch cord for Plastic Optical Fiber (POF)		
简图/Dimension	描述 / Description	Art.-No.
	Toslink plastic plug , simplex with 4.0mm PE POF black cable Toslink 塑料头,单工4.0mm PE POF黑色光缆	KINZ-PC-F05009
	Toslink Gold plug , simplex with 4.0mm PE POF black cable Toslink 金属头,单工4.0mm PE POF黑色光缆	KINZ-PC-F05010
	High Quality Toslink plastic Plug with Metal shell,simplex with 4.0mm PVC POF black cable (white/black/yellow connector) 高质量Toslink塑料插头带金属壳, 单工4.0mm PVC POF黑色电缆 (白色/黑色/黄色连接器)	KINZ-PC-F05011
	High Quality Toslink Gold Plug with Metal shell,simplex with 5.0mm braid POF black cable (white/black/yellow connector) 高质量Toslink金属插头带金属壳, 单工5.0mm编织POF黑色电缆 (白色/黑色/黄色连接器)	KINZ-PC-F05012

*POF=Polymer fiber/*POF=聚合物光纤

All patch cord with dust cap/所有跳线带防尘帽

Can be further customized according to the requirements/可根据要求进行进一步定制

**Assembled POF
Cables/组装POF光
缆**

F-05塑料光纤跳线 (POF) F-05 Patch cord for Plastic Optical Fiber (POF)		
简图/Dimension	描述 / Description	Art.-No.
	High Quality Toslink plastic Plug with black Metal shell,simplex with 5.0mm braid POF black cable 高质量Toslink塑料头带黑色金属壳,单工5.0mm编织POF黑色电缆	KINZ-PC-F05013
	High Quality Toslink Gold Plug with white Metal shell,simplex with 5.0mm braid POF gray cable 高质量Toslink金属头带白色金属壳,单工5.0mm编织POF灰色电缆	KINZ-PC-F05014
	High Quality Toslink Gold Plug with yellow Metal shell,simplex with 5.0mm braid POF gray cable 高质量Toslink金属头带黄色金属壳,单工5.0mm编织POF灰色电缆	KINZ-PC-F05015
	High Quality Toslink Gold Plug with white Metal shell,simplex with 5.0mm braid POF gray cable 高质量Toslink金属头带白色金属壳,单工5.0mm编织POF灰色电缆	KINZ-PC-F05016

*POF=Polymer fiber/*POF=聚合物光纤

All patch cord with dust cap/所有跳线带防尘帽

Can be further customized according to the requirements/可根据要求进行进一步定制

**Assembled POF
Cables/组装POF光
缆**

F-05塑料光纤跳线 (POF) F-05 Patch cord for Plastic Optical Fiber (POF)		
简图/Dimension	描述 / Description	Art.-No.
	High Quality Toslink plastic Plug with white Metal shell, simplex with 5.0mm thin braid POF gray cable 高质量Toslink塑料头带白色金属壳,单工5.0mm细编织POF灰色电缆	KINZ-PC-F05017
	High Quality Toslink plastic Plug with yellow Metal shell, simplex with 5.0mm thin braid POF gray cable 高质量Toslink塑料头带黄色金属壳,单工5.0mm细编织POF灰色电缆	KINZ-PC-F05018
	High Quality Toslink plastic Plug with white Metal shell, simplex with 5.0mm thick braid POF gray cable 高质量Toslink塑料头带白色金属壳,单工5.0mm厚编织POF灰色电缆	KINZ-PC-F05019
	High Quality Toslink plastic Plug with yellow Metal shell, simplex with 5.0mm thick braid POF gray cable 高质量Toslink塑料头带黄色金属壳,单工5.0mm厚编织POF灰色电缆	KINZ-PC-F05020

*POF=Polymer fiber/*POF=聚合物光纤

All patch cord with dust cap/所有跳线带防尘帽

Can be further customized according to the requirements/可根据要求进行进一步定制

Assembled
 POF&FO
 Cables/组装
 POF&FO光缆

F-05&F-07光纤跳线 F-05&F-07 Patch cord for POF&HPCS		
简图/Dimension	描述 / Description	Art.-No.
	F-05,Tocp155, simplex, with 1.0 x 2.2mm PE POF black cable F-05,Tocp155, 单工, 1.0 x 2.2mm PE POF 黑色光缆	KINZ-PC-F05F07001
	F-05,Tocp172, simplex, with 1.0 x 2.2mm PE POF black cable F-05,Tocp172, 单工, 1.0 x 2.2mm PE POF 黑色光缆	KINZ-PC-F05F07002
	F-05, CF-1571, simplex, with 200/230um x 2.2mm PVC HPCS orange cable F-05, CF-1571, 单工, 200/230um x 2.2mm PVC HPCS橙色光缆	KINZ-PC-F05F07003
	F-05, CF-1501, simplex, with 200/230um x 2.2mm PVC HPCS orange cable F-05, CF-1501, 单工, 200/230um x 2.2mm PVC HPCS橙色光缆	KINZ-PC-F05F07004
	F-05, CF-151, simplex, with 200/230um x 2.2mm PVC HPCS orange cable F-05, CF-151, 单工, 200/230um x 2.2mm PVC HPCS橙色光缆	KINZ-PC-F05F07005

*POF=Polymer fiber/*POF=聚合物光纤



*HPCS=Quartz fiber*HPCS=石英光纤

All patch cord with dust cap/所有跳线带防尘帽

Can be further customized according to the requirements/可根据要求进行进一步定制

F-05&F-07光纤跳线

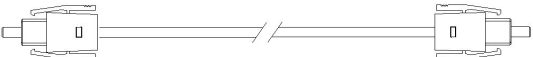
F-05&F-07 Patch cord for POF&HPCS

简图/Dimension	描述 / Description	Art.-No.
	F-05,Tocp100, simplex, with 1.0 x 2.2mm PE POF black cable F-05,Tocp100, 单工, 1.0 x 2.2mm PE POF 黑色光缆	KINZ-PC-F05F07006
	F-05, Tocp100, simplex, with 200/230um x 2.2mm PVC HPCS orange cable F-05, Tocp100, 单工, 200/230um x 2.2mm PVC HPCS橙色光缆	KINZ-PC-F05F07007
	F-05, CF-1001, simplex, with 200/230um x 2.2mm PVC HPCS orange cable F-05, CF-1001, 单工, 200/230um x 2.2mm PVC HPCS橙色光缆	KINZ-PC-F05F07008
	F-05, CF-1071, simplex, with 200/230um x 2.2mm PVC HPCS orange cable F-05, CF-1071, 单工, 200/230um x 2.2mm PVC HPCS橙色光缆	KINZ-PC-F05F07009
		F-05, CA7103, simplex, with 200/230um x 2.2mm PVC HPCS orange cable F-05, CA7103, 单工, 200/230um x 2.2mm PVC HPCS橙色光缆
F-05, SGK S01-L1, simplex, with 200/230um x 2.2mm PVC HPCS orange cable F-05, SGK S01-L1, 单工, 200/230um x 2.2mm PVC HPCS橙色光缆		KINZ-PC-F05F07011

*POF=Polymer fiber/*POF=聚合物光纤

*HPCS=Quartz fiber*HPCS=石英光纤

All patch cord with dust cap/所有跳线带防尘帽

Can be further customized according to the requirements/可根据要求进行进一步定制

F-05&F-07光纤跳线

F-05&F-07 Patch cord for POF&HPCS

简图/Dimension	描述 / Description	Art.-No.
	F-07, Original/Replacement, SSCNET III,MR-J3BUS1M,Duplex,with 1.0/2.2 x 4.4mm PE,POF black cable F-07,进口/替代,SSCNET III, MR-J3BUS1M, 双工,1.0/2.2 x 4.4mm PE, POF黑色光缆	KINZ-PC-F05F07012
	F-07, Original/Replacement, SSCNET III,MR-J3BUS1M,Duplex,with 1.0/2.2 x 4.4 x6.0mm PE,POF black cable F-07,进口/替代,SSCNET III, MR-J3BUS1M,双工,1.0/2.2 x 4.4mm x6.0mm PE, POF黑色光缆	KINZ-PC-F05F07013
	F-07,SSCNET III,MR-J3BUS1M-A,Duplex,with 1.0/2.2 x 4.4mm PE,POF black cable F-07,SSCNET III, MR-J3BUS03M-A, 双工, 1.0/2.2 x 4.4mm PE,POF黑色光缆	KINZ-PC-F05F07014
	F-07,SSCNET III,MR-J3BUS1M-A,Duplex,with 1.0/2.2 x 4.4 x6.0mm PE,POF black cable F-07,SSCNET III, MR-J3BUS03M-A, 双工, 1.0/2.2 x 4.4 x6.0mm PE,POF黑色光缆	KINZ-PC-F05F07015
	F-07, SSCNET III,MR-J3BUS1M-B,Duplex,with 1.0/2.2 x 4.4 mm PE,POF grey cable F-07,SSCNET III, MR-J3BUS03M-B, 双工, 1.0/2.2 x 4.4 mm PE,POF灰色光缆	KINZ-PC-F05F07016

*POF=Polymer fiber/*POF=聚合物光纤

*HPCS=Quartz fiber*HPCS=石英光纤

All patch cord with dust cap/所有跳线带防尘帽

Can be further customized according to the requirements/可根据要求进行进一步定制





Shen Zhen Kinz Optoelectric Technology Co.,Ltd.

Fiberkinz

“The POF Solutions Company”

F-05&F-07光纤跳线

F-05&F-07 Patch cord for POF&HPCS

简图/Dimension	描述 / Description	Art.-No.
	<p>F-07, SSCNET III,MR-J3BUS1M-B,Duplex,with 1.0/2.2 x 4.4 x6.0mm PE,POF grey cable</p> <p>F-07,SSCNET III, MR-J3BUS03M-B, 双工, 1.0/2.2 x 4.4 x6.0mm PE,POF灰色光缆</p>	<p>KINZ-PC-F05F07017</p>
	<p>F-07, AMP Servo, duplex, with 10/2.2x4.4x6.0mm PE POF black cable</p> <p>F-07, AMP 伺服,双工, 10/2.2x4.4x6.0mm PE POF 黑色光缆</p>	<p>KINZ-PC-F05F07018</p>
	<p>F-07, AMP Servo, duplex, with 200/230x 2.2x4.4x6.0mm PVC HPCS orange cable</p> <p>F-07, AMP 伺服,双工, 200/230um x 2.2x4.4x6.0mm PVC HPCS 橙色光缆</p>	<p>KINZ-PC-F05F07019</p>
	<p>QG-G50-2C-17M-B-LL/QJ71GP21-SX model/Mitsubishi PLC servo fiber cable</p> <p>QG-G50-2C-17M-B-LL/QJ71GP21-SX模/三菱 PLC伺服光纤</p>	<p>KINZ-PC-F05F07020</p>

*POF=Polymer fiber/*POF=聚合物光纤



*HPCS=Quartz fiber*HPCS=石英光纤

All patch cord with dust cap/所有跳线带防尘帽

Can be further customized according to the requirements/可根据要求进行进一步定制

F-05&F-07光纤跳线

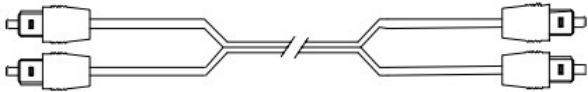
F-05&F-07 Patch cord for POF&HPCS

简图/Dimension	描述 / Description	Art.-No.
	F-05, duplex, with 1.0/2.2 x 4.4mm PE POF black cable	KINZ-PC-F05F07021
	F-05,双工, 1.0/2.2 x 4.4mm PE POF 黑色光缆	
	F-07,TOCP200, duplex, with 1.0/2.2 x 4.4mm PE POF black cable	KINZ-PC-F05F07022
	F-07,TOCP200,双工,1.0/2.2 x 4.4mm PE POF 黑色光缆	
	F-05,TOCP255, duplex, with 2.2x4.4mm PE POF cable	KINZ-PC-F05F07023
	F-05,TOCP255,双工,2.2x4.4mm PE POF跳线	
	F-07,TOCP200, duplex, with 200/230um x2.2mm PVC HPCS orange cable	KINZ-PC-F05F07024
	F-07,TOCP200,双工,200/230um x 2.2mm PVC HPCS 橙色色光缆	
	F-07,TOCP201, duplex, with 200/230um x2.2mm PVC HPCS orange cable	KINZ-PC-F05F07025
	F-07,TOCP201,双工,200/230um x 2.2mm PVC HPCS 橙色色光缆	
F-07,TOCP201QK, duplex, with 200/230um x2.2mm PVC HPCS orange cable	KINZ-PC-F05F07026	
F-07,TOCP201QK,双工,200/230um x 2.2mm PVC HPCS 橙色光缆		

*POF=Polymer fiber/*POF=聚合物光纤



*HPCS=Quartz fiber*HPCS=石英光纤

All patch cord with dust cap/所有跳线带防尘帽

Can be further customized according to the requirements/可根据要求进行进一步定制

F-05&F-07光纤跳线

F-05&F-07 Patch cord for POF&HPCS

简图/Dimension	描述 / Description	Art.-No.
	F-07,TOCP201QK, duplex, with 200/230um x 2.2 x 4.4 x 6.0mm PVC HPCS orange cable(with accessory) F-07,TOCP201QK,双工,200/230um x 2.2 x 4.4 x 6.0mm PVC HPCS 橙色光缆(带配件)	KINZ-PC-F05F07027
	F-07,CF-2001, duplex, with 200/230um x 2.2mm PVC HPCS orange cable F-07,CF-2001,双工,200/230um x 2.2mm PVC HPCS 橙色光缆	KINZ-PC-F05F07028
	F-07,CF-2071, duplex, with 200/230um x 2.2mm PVC HPCS orange cable F-07,CF-2071,双工,200/230um x 2.2mm PVC HPCS 橙色光缆	KINZ-PC-F05F07029
	F-07, DL-72, duplex, with 200/230um x 2.2mm PVC HPCS orange cable F-07, DL-72,双工,200/230um x 2.2mm PVC HPCS 橙色光缆	KINZ-PC-F05F07030
	F-07, DL-72ME/AS-2P-40M-P, duplex, with 200/230um x 2.2mm PVC HPCS orange cable F-07, DL-72ME/AS-2P-40M-P 双工,200/230um x 2.2mm PVC HPCS 橙色光缆	KINZ-PC-F05F07031

*POF=Polymer fiber/*POF=聚合物光纤

*HPCS=Quartz fiber*HPCS=石英光纤

All patch cord with dust cap/所有跳线带防尘帽

Can be further customized according to the requirements/可根据要求进行进一步定制

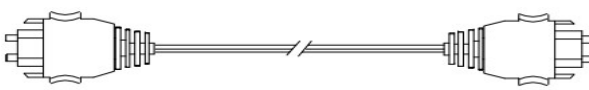
F-05&F-07光纤跳线 F-05&F-07 Patch cord for POF&HPCS		
简图/Dimension	描述 / Description	Art.-No.
	F-07, CA7003, duplex, with 200/230um x 2.2mm PVC HPCS orange cable F-07, CA7003,双工,200/230um x 2.2mm PVC HPCS 橙色光缆	KINZ-PC-F05F07032
	F-07, SGK S01-L2, duplex, with 200/230um x 2.2mm PVC HPCS orange cable F-07, SGK S01-L2,双工,200/230um x 2.2mm PVC HPCS 橙色光缆	KINZ-PC-F05F07033
	F-07, CA9003, duplex, with 200/230um x 2.2mm PVC HPCS orange cable F-07,CA9003,双工,200/230um x 2.2mm PVC HPCS 橙色光缆	KINZ-PC-F05F07034
	F-07, CF-2501, duplex, with 200/230um x 2.2mm PVC HPCS orange cable F-07,CF-2501,双工,200/230um x 2.2mm PVC HPCS 橙色光缆	KINZ-PC-F05F07035

*POF=Polymer fiber/*POF=聚合物光纤

*HPCS=Quartz fiber*HPCS=石英光纤

All patch cord with dust cap/所有跳线带防尘帽

Can be further customized according to the requirements/可根据要求进行进一步定制

Assembled POF
Cables
/组装POF光缆

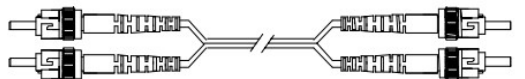

ST 光纤跳线 For POF& HPCS& Glass ST Fiber Optic Patch cord For POF& HPCS& Glass		
ST Plastic Fiber 1mm (POF) ST 塑料光纤1mm (POF)		
简图/Dimension	描述 / Description	Art.-No.
	Patch cable simplex 单工跳线	
	F-ST, simplex with 1.0*2.2mm PE POF black cable F-ST,1.0*2.2 PE POF 单工黑色光缆	KINZ-PC-ST-01
	ST-ST,simplex with 1.0*2.2 PE POF black cable with Custom thread ST-ST,1.0*2.2 PE POF 单工黑色光缆定制螺纹	KINZ-PC-ST-02
	ST-ST,simplex with 1.0*1.5*2.3mm PA POF cable Orange ST-ST,1.0*1.5*2.3mm PA POF 单工橙色光缆	KINZ-PC-ST-03
	F-ST, simplex with 3.6mm SERCOS interface cable F-ST,3.6mm SERCOS 接口单工光缆	KINZ-PC-ST-04
	G-ST, simplex with 6.0mm SERCOS interface cable G-ST,6.0mm SERCOS接口单工光缆	KINZ-PC-ST-05
		Patch cable duplex 双工跳线
F-ST, duplex, with 4.4mm PE POF cable F-ST,4.4mm PE POF 双工光缆		KINZ-PC-ST-06
ST-ST, duplex, with 6mm PUR POF cable ST-ST, 6mm PUR POF 双工光缆		KINZ-PC-ST-07

*POF=Polymer fiber/*POF=聚合物光纤

All patch cord with dust cap/所有跳线带防尘帽

Can be further customized according to the requirements/可根据要求进行进一步定制

Assembled POF
Cables
/组装POF光缆

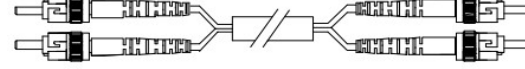
ST 200/230µm Cable ST 200/230µm 光缆		
简图 /Dimension	描述 / Description	Art.-No.
	Patch cable simplex 单工跳线	
	HCS 200/230um, single, hard pack -layer quartz fiber HCS 200/230um,单工,硬包层石英光纤	KINZ-PC-ST-8
	HCS 400/440um, single, hard pack -layer quartz fiber HCS 400/440um,单工,硬包层石英光纤	KINZ-PC-ST-9
	HCS 600/660um, single, hard pack -layer quartz fiber HCS 600/660um,单工,硬包层石英光纤	KINZ-PC-ST-10
	Patch cable duplex 双工跳线	
	F-ST, duplex F-ST, 双工	KINZ-PC-ST-11
	HCS ST,200/230 duplex, Bachman Wind Power Optical Okoma Optical Fiber HCS ST,200/230,双工,巴赫曼风电光纤光奥柯玛光纤	KINZ-PC-ST-12

*HPCS=Quartz fiber*HPCS=石英光纤



All patch cord with dust cap/所有跳线带防尘帽

Can be further customized according to the requirements/可根据要求进行进一步定制

Shen Zhen Kinz Optoelectric Technology Co.,Ltd.

Fiberkinz

“The POF Solutions Company”

ST Glass Fiber 50/125 μ m ST 玻璃光纤50/125 μ m		
简图 /Dimension	描述 / Description	Art.-No.
	F-ST, duplex F-ST, 双工	KINZ-PC-ST-13
ST Glass Fiber 62.5/125 μ m ST 玻璃光纤62.5/125 μ m		
简图 /Dimension	描述 / Description	Art.-No.
	Patch cable simplex 单工跳线	KINZ-PC-ST-14
	F-ST, simplex F-ST, 单工	
	Patch cable duplex 双工跳线光缆	KINZ-PC-ST-15
	F-ST, duplex F-ST, 双工	

*HPCS=Quartz fiber*HPCS=石英光纤

All patch cord with dust cap/所有跳线带防尘帽

Can be further customized according to the requirements/可根据要求进行进一步定制

Shen Zhen Kinz Optoelectric Technology Co.,Ltd.

Fiberkinz

“The POF Solutions Company”

Assembled POF
Cables
/组装POF光缆

FC 光纤跳线 For POF& HPCS& Glass FC Fiber Optic Patch cord For POF& HPCS& Glass		
FC 塑料光纤1mm (POF) FC Plastic Fiber 1mm (POF)		
简图 /Dimension	描述 / Description	Art.-No.
	Patch cable simplex 单工跳线	
	FC-250um, simplex with 2.2mm PE POF white Arc Protection cable FC-250um, 2.2mm PE POF 单工白色弧光保护光缆	KINZ-PC-FC-01
	FC-500um, simplex with 2.2mm PE POF black/Transparent cable FC-500um,2.2mm PE POF 单工黑色/本色光缆	KINZ-PC-FC-02
	FC-1000um, simplex with 2.2mm PE POF black/Yellow/transparent cable FC-1000um,2.2mm PE POF 单工黑色/黄色/本色 光缆	KINZ-PC-FC-03

*POF=Polymer fiber/*POF=聚合物光纤

All patch cord with dust cap/所有跳线带防尘帽



Can be further customized according to the requirements/可根据要求进行进一步定制

Shen Zhen Kinz Optoelectric Technology Co.,Ltd.

Fiberkinz

“The POF Solutions Company”

Assembled POF
Cables
/组装POF光缆

简图 /Dimension	描述 / Description	Art.-No.
	FC-FC with knurled nut, simplex, FC-FC带滚花螺母，单工	KINZ-PC-FC-04
FC 200/230μm 光缆 FC 200/230μm Cable		
简图 /Dimension	描述 / Description	Art.-No.
	FC-FC with knurled nut, simplex FC-FC 带滚花螺母,单工	KINZ-PC-FC-05

*HPCS=Quartz fiber*HPCS=石英光纤

All patch cord with dust cap/所有跳线带防尘帽

Can be further customized according to the requirements/可根据要求进行进一步定制



Assembled POF
Cables
/组装POF光缆

SC 光纤跳线For POF& HPCS& Glass SC Fiber Optic Patch cord For POF& HPCS& Glass		
SC 塑料光纤1mm (POF) SC Plastic Fiber 1mm (POF)		
简图 /Dimension	描述 / Description	Art.-No.
	SC-SC, duplex, with 2.2mm PE POF cable SC-SC,双工,2.2mm PE POF 单工光缆	KINZ-PC-SC-01
	SC-SC, duplex, with 2.2*6.0mm PE POF cable SC-SC,双工,2.2*6.0mm PE POF单工光缆	KINZ-PC-SC-02

*POF=Polymer fiber/*POF=聚合物光纤

All patch cord with dust cap/所有跳线带防尘帽

Can be further customized according to the requirements/可根据要求进行进一步定制

SC 200/230μm 光缆 SC 200/230μm Cable		
简图 /Dimension	描述 / Description	Art.-No.
	Patch cable duplex 双工跳线	
	SC, duplex SC, 双工	KINZ-PC-SC-03
SC玻璃光纤50/125μm SC Glass Fiber 50/125μm		
简图 /Dimension	描述 / Description	Art.-No.
	SC, duplex SC, 双工	KINZ-PC-SC-04
	SC, duplex SC, 双工	KINZ-PC-SC-05
SC 玻璃光纤62.5/125μm SC Glass Fiber 62.5/125μm		
简图 /Dimension	描述 / Description	Art.-No.
	Patch cable duplex 双工跳线光缆	
	SC, duplex SC, 双工	KINZ-PC-SC-06

*HPCS=Quartz fiber*HPCS=石英光纤

All patch cord with dust cap/所有跳线带防尘帽

Can be further customized according to the requirements/可根据要求进行进一步定制

Shen Zhen Kinz Optoelectric Technology Co.,Ltd.

Fiberkinz

“The POF Solutions Company”

Assembled POF
Cables
/组装POF光缆



LC 光纤跳线For POF LC Fiber Optic Patch cord For POF		
LC 塑料光纤 (POF) LC Plastic Fiber (POF)		
简图/Dimension	描述 / Description	Art.-No.
	LC-LC white, simple, with 750um POF black cable LC-LC白色,单工,2.2mm PE POF 单工黑色光缆	KINZ-PC-LC-01
	LC-LC black, simple, with 1000um POF black cable LC-LC黑色,单工,1000um POF 单工黑色光缆	KINZ-PC-LC-02

*POF=Polymer fiber/*POF=聚合物光纤

All patch cord with dust cap/所有跳线带防尘帽

Can be further customized according to the requirements/可根据要求进行进一步定制

Assembled POF
Cables
/组装POF光缆



Sma905 光纤跳线 For POF& HPCS& Glass Sma905 Fiber Optic Patch cord For POF& HPCS& Glass		
Sma905 塑料光纤1mm (POF) Sma905 Plastic Fiber 1mm (POF)		
	Patch cable simplex 单工跳线	
	Sma905-Sma905, simplex with 2.2mm PE POF black cable Sma905-Sma905, 2.2mm PE POF 单工黑色光缆	KINZ-PC-SMA905-01
	Sma905-Sma905, simplex with 3.65mm PE POF red Kato cable Sma905-Sma905,3.65mm PE POF 单工红色加藤光缆	KINZ-PC-SMA905-02
	FSMA905 2.75mm, simplex with 2.2mm PE POF black cable FSMA905 2.75mm,2.2mm PE POF 单工黑色光缆	KINZ-PC-SMA905-03
	SMA-G with hex. nut, simplex with 6.0mm SERCOS interface cable SMA-G 带Hex螺母,6.0mm SERCOS接口单工光缆	KINZ-PC-SMA905-04
	SMA-F with knurled nut, simplex with 2000um PE POF* cable SMA-F 带滚花螺母, 2000um PE POF 单工光缆	KINZ-PC-SMA905-05

*POF=Polymer fiber/*POF=聚合物光纤

All patch cord with dust cap/所有跳线带防尘帽

Can be further customized according to the requirements/可根据要求进行进一步定制





Assembled POF
Cables
/组装POF光缆

Sma905 光纤跳线For POF& HPCS& Glass Sma905 Fiber Optic Patch cord For POF& HPCS& Glass		
Sma905 塑料光纤1mm (POF) Sma905 Plastic Fiber 1mm (POF)		
	Patch cable duplex 双工跳线	
	F-SMA with knurled nut, duplex with 2.2x4.4mm PE POF F-SMA带滚花螺母, 2.2x4.4mm PE POF 双工光缆	KINZ-PC-SMA905-06
	F-SMA with hex. nut, duplex, with 2.2 x 4.4mm PE POF cable F-SMA带hex. 螺母, 2.2 x 4.4mm PE POF 双工光缆	KINZ-PC-SMA905-07
	F-SMA with knurled nut, duplex with 6mm PUR POF cable, PE inner jacket F-SMA带滚花螺母, 6mm PUR POF 双工光缆, PE 内护套	KINZ-PC-SMA905-08
	F-SMA with knurled nut, duplex with 9mm PUR POF cable, PA inner jacket F-SMA带滚花螺母, 9 mm PUR POF 双工光缆, PA 内护套	KINZ-PC-SMA905-09

*POF=Polymer fiber/*POF=聚合物光纤

All patch cord with dust cap/所有跳线带防尘帽

Can be further customized according to the requirements/可根据要求进行进一步定制

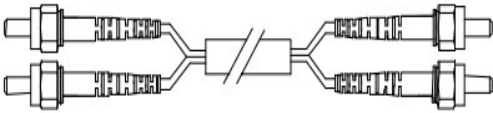
Sma905 玻璃光纤单工100/140μm Sma905 Glass Fiber 100/140μm simplex		
简图 /Dimension	描述 / Description	Art.-No.
	F-SMA with knurled nut, simplex, F-SMA带有滚花螺母, 单工	KINZ-PC-SMA905-10
Sma905 200/230μm Cable Sma905 200/230μm 光缆		
简图 /Dimension	描述 / Description	Art.-No.
	Patch cable simplex 单工跳线	
	F-SMA with hex. nut, simplex F-SMA带hex. 螺母, 单工	KINZ-PC-SMA905-11
	Sma905-Sma905, 200/230UM,simplex with 2.2mm PE orange cable Sma905-Sma905,200/230UM,2.2 PE 单工橙 色光缆	KINZ-PC-SMA905-12
	Patch cable duplex 双工跳线	
	F-SMA with knurled nut, duplex F-SMA带滚花螺母, 双工	KINZ-PC-SMA905-13
	F-SMA with knurled nut, duplex, 7mm cable PUR-jacket red F-SMA 带滚花螺母,双工,7mm光缆PUR护套 红色	KINZ-PC-SMA905-14
	F-SMA with knurled nut, duplex, 10.9mm outdoor cable F-SMA带滚花螺母,双工,10.9mm户外光缆	KINZ-PC-SMA905-15

*HPCS=Quartz fiber*HPCS=石英光纤

All patch cord with dust cap/所有跳线带防尘帽



Can be further customized according to the requirements/可根据要求进行进一步定制

Shen Zhen Kinz Optoelectric Technology Co.,Ltd.

Fiberkinz

“The POF Solutions Company”

Assembled POF
Cables
/组装POF光缆

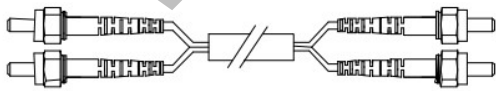
Sma905 玻璃光纤50/125μm Sma905 Glass Fiber 50/125μm		
简图 /Dimension	描述 / Description	Art.-No.
	Patch cable simplex 单工跳线	
	F-SMA, simplex F-SMA, 单工	KINZ-PC-SMA905-16
	F-SMA, simplex F-SMA, 单工	KINZ-PC-SMA905-17
	Patch cable duplex 双工跳线光缆	
	F-SMA, duplex F-SMA, 双工	KINZ-PC-SMA905-18
	F-SMA, duplex F-SMA, 双工	KINZ-PC-SMA905-19
	F-SMA, duplex F-SMA, 双工	KINZ-PC-SMA905-20

Shen Zhen Kinz Optoelectric Technology Co.,Ltd.

Fiberkinz

“The POF Solutions Company”

Assembled POF
Cables
/组装POF光缆

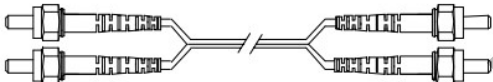
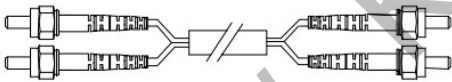
Sma905 玻璃光纤62.5/125μm Sma905 Glass Fiber 62.5/125μm		
简图 /Dimension	描述 / Description	Art.-No.
	Patch cable simplex 单工跳线	
	F-SMA, simplex F-SMA, 单工	KINZ-PC-SMA905-21
	Patch cable duplex 双工跳线光缆	
	F-SMA, duplex F-SMA, 双工	KINZ-PC-SMA905-22
	F-SMA, duplex F-SMA, 双工	KINZ-PC-SMA905-23

*HPCS=Quartz fiber*HPCS=石英光纤

All patch cord with dust cap/所有跳线带防尘帽

Can be further customized according to the requirements/可根据要求进行进一步定制

Shen Zhen Kinz Optoelectric Technology Co.,Ltd.

Fiberkinz

“The POF Solutions Company”

Assembled POF
Cables
/组装POF光缆

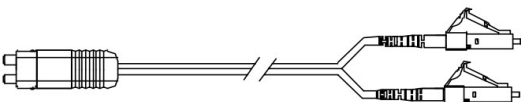



SMI 光纤跳线For POF SMI Fiber Optic Patch cord For POF		
SMI 塑料光纤1mm (POF) SMI Plastic Fiber 1mm (POF)		
	<p>SMI 1394 LAN multi -mode fiber with PE POF black cable SMI 1394 LAN Multi -Mode带PE POF 黑色光缆</p>	<p>KINZ-PC-SMI-01</p>
	<p>SC-SMI,duplex, with 1.0x 2.2mm PE POF black cable SC-SMI,双工,1.0x 2.2mm PE POF 黑色光缆</p>	<p>KINZ-PC-SMI-02</p>

*POF=Polymer fiber/*POF=聚合物光纤

All patch cord with dust cap/所有跳线带防尘帽

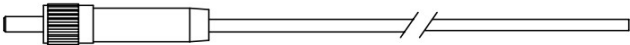
Can be further customized according to the requirements/可根据要求进行进一步定制

**Assembled POF
 Cables/组装POF
 光缆**

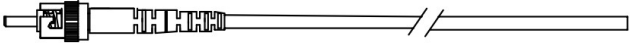
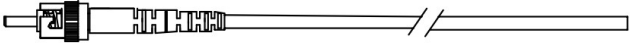





POF 光纤跳线 Fiber Optic Patch cord For POF		
塑料光纤1mm (POF) Plastic Fiber 1mm (POF)		
简图 /Dimension	描述 / Description	Art.-No.
	Sma905 pigtail,simplex Fluorescent fiber red and green orange Sma905尾纤,单工,荧光光纤红绿橙	KINZ-PC-OTH-01
	Sma905 pigtail,simplex with 2.2mm PE POF blue cable Sma905尾纤,2.2mm PE POF 单工蓝色光缆	KINZ-PC-OTH-02
	SMA905 pigtail,simplex with 1.0*1.5*2.3mm PA POF cable Orange ST尾纤,1.0*1.5*2.3mm PA POF 单工橙色光缆	KINZ-PC-OTH-03
	Sma905-500UM pigtail, simplex with 2.2mm PE POF black cable-Capillary Sma905-500UM尾纤,2.2mm PE POF 单工黑色光缆-毛细管黑色特种	KINZ-PC-OTH-04
	ST pigtail,simplex with 2.2mm PE POF Black cable ST 尾纤,2.2mm PE POF 单工黑色光缆	KINZ-PC-OTH-05
	ST large core diameter resistant high temperature arc optical fiber cable ST大芯径耐高温电弧光光纤线	KINZ-PC-OTH-06

*POF=Polymer fiber/*POF=聚合物光纤

All patch cord with dust cap/所有跳线带防尘帽

Can be further customized according to the requirements/可根据要求进行进一步定制

**Assembled POF
 Cables/组装POF
 光缆**





POF 光纤跳线 Fiber Optic Patch cord For POF		
塑料光纤1mm (POF) Plastic Fiber 1mm (POF)		
	FC pigtail, simplex with 2.2mm PE POF cable black FC尾纤, 2.2mm PE POF 单工黑色光缆	KINZ-PC-OTH-07
	Sma905-FC, simplex with 2.2mm PE POF black cable Sma905-FC, 2.2mm PE POF 单工黑色光缆	KINZ-PC-OTH-08
	Sma905-ST, simplex with 2.2mm PE POF black cable Sma905-ST, 2.2mm PE POF 单工黑色光缆	KINZ-PC-OTH-09
	Sma905-Sma905 Probe, simplex with 2.2mm PE POF red cable Sma905-Sma905探头, 2.2mm PE POF 单工红色光缆	KINZ-PC-OTH-10
	SMA905-sma905, 200230UM 2.2mm PE WITH collimator 6mm SMA905-SMA905, 200230UM 2.2mm PE, 准直器6mm	KINZ-PC-OTH-11
	ST-SC, simplex with 2.2mm PE POF cable Black ST-SC, 2.2mm PE POF 单工黑色光缆	KINZ-PC-OTH-12
	FC-SC, Simplex, with 1.0x 2.2mm PE POF black cable FC-SC, 单工, 1.0x 2.2mm PE POF 黑色光缆	KINZ-PC-OTH-13

*POF=Polymer fiber/*POF=聚合物光纤

All patch cord with dust cap/所有跳线带防尘帽

Can be further customized according to the requirements/可根据要求进行进一步定制

**Assembled POF
 Cables/组装POF光
 缆**







Plastic Fiber 1mm (POF) 塑料光纤1mm (POF)		
简图 /Dimension	描述 / Description	Art.-No.
	Patch cable simplex 单工跳线	
	HFBR-4501/4511, simplex with 2.2mm PE POF cable HFBR-4501/4511,2.2mm PE POF 单工光缆	KINZ-PC-HFBR-01
	HFBR-4501/4511 with tail, simplex with 2.2*6.0mm PE POF Orange cable HFBR-4501/4511 带尾套,2.2*6.0mm PE POF 单工橙色光缆	KINZ-PC-HFBR-02
	HFBR-4503/4513, simplex with 2.2mm PE POF cable HFBR-4503/4513,2.2mm PE POF 单工光缆	KINZ-PC-HFBR-03
	HFBR 4503-ST, simplex with 2.2mm PE POF new energy cable HFBR 4503-ST,2.2mm PE POF 单工新能源光缆	KINZ-PC-HFBR-04
	HFBR 4513-ST, simplex with 2.2mm PE POF cable HFBR 4513-ST,2.2mm PE POF 单工光缆	KINZ-PC-HFBR-05

*POF=Polymer fiber/*POF=聚合物光纤

All patch cord with dust cap/所有跳线带防尘帽

Can be further customized according to the requirements/可根据要求进行进一步定制

**Assembled POF
 Cables/组装POF光
 缆**

Plastic Fiber 1mm (POF) 塑料光纤1mm (POF)		
简图 /Dimension	描述 / Description	Art.-No.
	HFBR-4531, simplex with 2.2mm PE POF cable HFBR-4531, 2.2mm PE POF 单工光缆	KINZ-PC-HFBR-06
	HFBR-4531, simplex with 6.0mm SER-COS interface cable HFBR-4531,6.0mm SER-COS接口单工光缆	KINZ-PC-HFBR-07
	HFBR-4531/4533, simplex with 2.2mm PE POF cable HFBR-4531/4533,2.2mm PE POF 单工光缆	KINZ-PC-HFBR-08
	HFBR-4532, simplex with 2.2mm PE POF cable HFBR-4532,2.2mm PE POF 单工光缆	KINZ-PC-HFBR-09
	HFBR-4533, simplex with 2.2mm PE POF cable HFBR-4533,2.2mm PE POF 单工光缆	KINZ-PC-HFBR-10
	HFBR-4533/4535, simplex with 2.2mm PE POF cable HFBR-4533/4535,2.2mm PE POF 单工光缆	KINZ-PC-HFBR-11
	HFBR-4535, simplex with 2.2mm PE POF cable HFBR-4535,2.2mm PE POF 单工光缆	KINZ-PC-HFBR-12
	SMA905-HFBR 4531z, simplex with 2.2*6.0mm PUR POF purple Flame retardant cable SMA905-HFBR 4531z,2.2*6.0mm PUR POF紫色阻燃单工光缆	KINZ-PC-HFBR-13

*POF=Polymer fiber/*POF=聚合物光纤

All patch cord with dust cap/所有跳线带防尘帽

Can be further customized according to the requirements/可根据要求进行进一步定制

**Assembled POF
 Cables / 组装POF光
 缆**

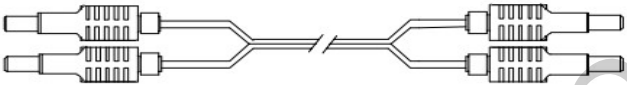
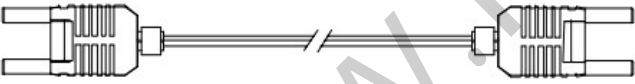
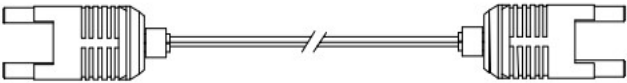

Plastic Fiber 1mm (POF) 塑料光纤1mm (POF)		
简图 / Dimension	描述 / Description	Art.-No.
	<p>Patch cable duplex 双工跳线</p>	
	<p>HFBR-4501/4511, duplex, with 2.2x4.4mm PE POF cable HFBR-4501/4511, 双工, 2.2x4.4mm PE POF 光缆</p>	KINZ-PC-HFBR-14
	<p>HFBR-4503/4513, duplex, with 2.2x4.4mm PE POF cable HFBR-4503/4513, 双工, 2.2x4.4mm PE POF 光缆</p>	KINZ-PC-HFBR-15
	<p>HFBR-4506, duplex, with 2.2x4.4mm PE POF cable HFBR-4506, 双工, 2.2x4.4mm PE POF 光缆</p>	KINZ-PC-HFBR-16
	<p>HFBR-4516, duplex, with 2.2x4.4mm PE POF* cable HFBR-4516, 双工, 2.2x4.4mm PE POF 光缆</p>	KINZ-PC-HFBR-17
	<p>HFBR-4506/4516, duplex, with 2.2x4.4mm PE POF* cable HFBR-4506/4516, 双工, 2.2x4.4mm PE POF 光缆</p>	KINZ-PC-HFBR-18

*POF=Polymer fiber/*POF=聚合物光纤

All patch cord with dust cap/所有跳线带防尘帽

Can be further customized according to the requirements/可根据要求进行进一步定制

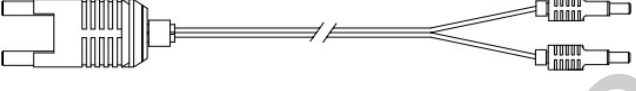
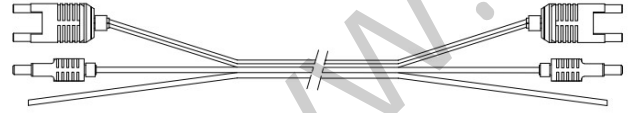
**Assembled POF
 Cables / 组装POF光
 缆**

Plastic Fiber 1mm (POF) 塑料光纤1mm (POF)		
简图 / Dimension	描述 / Description	Art.-No.
	HFBR-4531, duplex, with 2.2x4.4mm PE POF cable HFBR-4531, 双工, 2.2x4.4mm PE POF 光缆	KINZ-PC-HFBR-19
	HFBR 4516-4503 4513, duplex, with 2.2x4.4mm PE POF cable HFBR 4516-4503 4513, 双工, 2.2x4.4mm PE POF 光缆	KINZ-PC-HFBR-20
	HFBR 4503 4506-4513 4516, duplex, with 2.2x4.4x6.0mm PE POF cable HFBR 4503 4506-4513 4516, 双工, 2.2x4.4x6.0mm PE POF 光缆	KINZ-PC-HFBR-21
	HFBR 4501 4511-ST ST, duplex, with 2.2x4.4x6.0mm PE POF cable HFBR 4501 4511-ST ST, 双工, 2.2x4.4x6.0mm PE POF 光缆	KINZ-PC-HFBR-22



*POF=Polymer fiber/*POF=聚合物光纤

All patch cord with dust cap/所有跳线带防尘帽

Can be further customized according to the requirements/可根据要求进行进一步定制

Assembled POF
 Cables / 组装POF光
 缆

FO 200/230μm Cable
 FO 200/230μm 光缆

简图 / Dimension	描述 / Description	Art.-No.
	Patch cable simplex 单工跳线	
	HFBR4501-4511, V-pin black, simplex with FO 200/230μm blue Cable HFBR4501-4511, V-pin 黑色, FO 200/230 μm 单工蓝色光缆	KINZ-PC-HFBR-23
	HFBR 4521, V-pin blue/black, simplex with FO 200/230μm Cable HFBR 4521, V-pin 蓝色/黑色, FO 200/230μm 单工光缆	KINZ-PC-HFBR-24
	HFBR 4521, V-pin blue/black, duplex, with FO 200/230μm Cable HFBR 4521, V-pin 蓝色/黑色, FO 200/230μm 双工光缆	KINZ-PC-HFBR-25
	HFBR 4521, V-pin blue/black(BP04703), duplex, with FO 200/230μm Cable HFBR 4521, V-pin 蓝色/黑色(BP04703), FO 200/230μm 双工光缆	KINZ-PC-HFBR-26

*HPCS=Quartz fiber*HPCS=石英光纤



All patch cord with dust cap/所有跳线带防尘帽

Can be further customized according to the requirements/可根据要求进行进一步定制

Shen Zhen Kinz Optoelectric Technology Co., Ltd.

Fiberkinz
 “The POF Solutions Company”

Assembled POF
 Cables/组装POF
 光缆



MOST光纤跳线1mm (POF) MOST Patch cord 1mm For POF		
简图 /Dimension	描述 / Description	Art.-No.
	单工跳线 Patch cable simplex	
	MOST-Insert, Male/Male ,simplpex with 2.3mm MOST PA POF cable MOST-镶嵌, 公头/公头, 单工2.3mm MOST PA POF 单工光缆	KINZ-PC-MOST001
	MOST-Insert,1355532, Male/Male,simplpex with 2.3mm MOST PA POF cable MOST-镶嵌,1355532, 公头/公头,单工 2.3mm MOST PA POF 单工光缆	KINZ-PC-MOST002
	MOST-Insert,Mercedes -Benz brass, female/male,simplpex with 1.5 mm MOST PE POF cable MOST-镶嵌,奔驰黄铜套圈,母头/公头,单 工1.5mm MOST PE POF 光缆	KINZ-PC-MOST003

*POF=Polymer fiber/*POF=聚合物光纤

All patch cord with dust cap/所有跳线带防尘帽

Can be further customized according to the requirements/可根据要求进行进一步定制

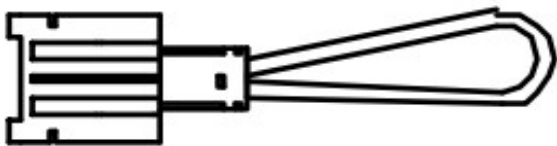
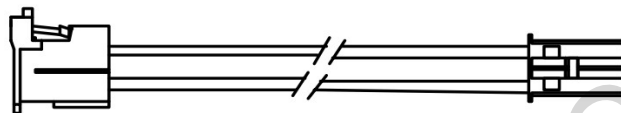
Assembled POF
 Cables/组装POF
 光缆

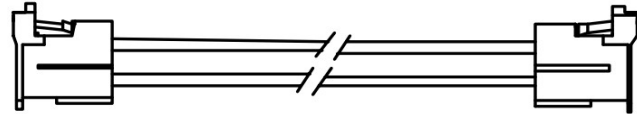

MOST光纤跳线1mm (POF) MOST Patch cord 1mm For POF		
简图 /Dimension	描述 / Description	Art.-No.
	双工跳线 Patch cable duplex	
	MOST-Insert,Tyco 13949162,duplex with 2.3mm MOST PA POF cable MOST-镶嵌,Tyco 13949162,双工2.3mm MOST PA POF光缆	KINZ-PC-MOST004
	MOST-Insert,1355426,female/Male,duplex with 2.3mm MOST PA POF cable MOST-镶嵌,1355426,母头/公头,双工 2.3mm MOST PA POF 光缆	KINZ-PC-MOST005
	MOST-Insert,1355531,Male/Male,duplex with 2.3mm MOST PA POF cable MOST-镶嵌,1355531,公头/公头,双工 2.3mm MOST PA POF 光缆	KINZ-PC-MOST006
	MOST-Insert,1355752,female/Male,duplex with 2.3mm MOST PA POF cable MOST-镶嵌,1355752,母头/公头,双工 2.3mm MOST PA POF 光缆	KINZ-PC-MOST007
	MOST-Insert,MOST Jumper, Male/Male,duplex with 2.3mm MOST PA POF cable MOST-镶嵌,MOST 光纤跳线,公头/公头, 双工2.3mm MOST PA POF 光缆	KINZ-PC-MOST008

*POF=Polymer fiber/*POF=聚合物光纤

All patch cord with dust cap/所有跳线带防尘帽

Can be further customized according to the requirements/可根据要求进行进一步定制

**Assembled POF
 Cables/组装POF
 光缆**





塑料光纤1mm 机车 (POF) Plastic Fiber 1mm Locomotive (POF)		
简图 /Dimension	描述 / Description	Art.-No.
	<p>Patch cable simplex 单工跳线</p>	
	<p>Ferrule, simplex with 2.2mm PE POF cable 套圈, 2.2mm PE POF单工光缆</p>	KINZ-PC-EMU001
	<p>RMPOF1000B, EMU control fiber cable simplex with 2.2mm PE POF cable</p> <p>RMPOF1000B,动车组控制光纤线, 2.2mm PE POF单工光缆</p>	KINZ-PC-EMU002
	<p>ST1000-RCPOF1000B, simplex with 2.2mm PE POF cable</p> <p>ST1000-RCPOF1000B, 2.2mm PE POF单工光缆</p>	KINZ-PC-EMU003

*POF=Polymer fiber/*POF=聚合物光纤

All patch cord with dust cap/所有跳线带防尘帽

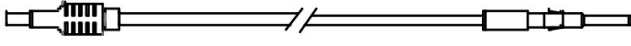
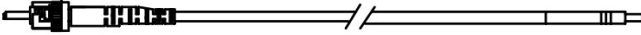
Can be further customized according to the requirements/可根据要求进行进一步定制

**Assembled POF
Cables/组装POF
光缆**



塑料光纤1mm 机车 (POF) Plastic Fiber 1mm Locomotive (POF)		
简图 /Dimension	描述 / Description	Art.-No.
	RMPOF1000B-HFBR4503z/4513z -L400 simplex with 2.2mm PE POF cable RMPOF1000B-HFBR4503z/4513z -L400 2.2mm PE POF单工光缆	KINZ-PC-EMU004
	ST-RMPOM1000B-yellow replacement, simplex with 2.2mm PE POF cable ST-RMPOM1000B-黄色替代 2.2mm PE POF单工光缆	KINZ-PC-EMU005
双工跳线 Patch cable duplex		
	HFBR-4503/4513-R15 male F.O.1mmPOF (U,D) 20 10 001 3212 duplex with 2.2mm PE POF braid cable HFBR-4503/4513-R15 male F.O.1mmPOF (U,D) 20 10 001 3212 2.2mm PE POF 双工编织光缆	KINZ-PC-EMU006
	RMPOF1000B-HFBR 4516z simplex with 2.2mm PE POF cable RMPOF1000B-HFBR 4516z 2.2mm PE POF单工光缆	KINZ-PC-EMU007
	HFBR 4503z-RMPOF1000B-yellow replacement,duplex with 2.2mm PE POF cable HFBR 4503z-RMPOF1000B-黄色替代, 2.2mm PE POF双工光缆	KINZ-PC-EMU008

*POF=Polymer fiber/*POF=聚合物光纤

All patch cord with dust cap/所有跳线带防尘帽

Can be further customized according to the requirements/可根据要求进行进一步定制

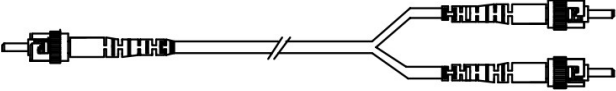
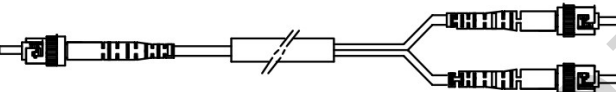
Assembled POF
 Cables/组装POF
 光缆

塑料光纤分路器1mm (POF) Plastic Fiber Splitter 1mm (POF)		
简图 /Dimension	描述 / Description	Art.-No.
	ST-ST-2 in 1 Plastic Fiber Splitter 2.2mm PE POF cable ST-ST- 1分2 塑料光纤分路器 2.2mm PE POF光缆	KINZ-PC-Splitter001
	ST-ST-2 in 1 Plastic Fiber Splitter 2.2mm PE POF cable ST-ST- 1分2塑料光纤分路器 2.2mm PE POF光缆	KINZ-PC-Splitter002
	ST-ST -Toslink audio-2 in 1 Plastic Fiber Splitter, 2.2mm PE POF cable ST-ST -Toslink audio-1分2 塑料光纤分路 器, 2.2mm PE POF 光缆	KINZ-PC-Splitter003
	HFBR-4503/4513z-2 in 1 Plastic Fiber Splitter, 2.2mm PE POF cable HFBR-4503/4513z-1分2 塑料光纤分路 器, 2.2mm PE POF 光缆	KINZ-PC-Splitter004

*POF=Polymer fiber/*POF=聚合物光纤

All patch cord with dust cap/所有跳线带防尘帽

Can be further customized according to the requirements/可根据要求进行进一步定制

Assembled POF
 Cables/组装POF
 光缆

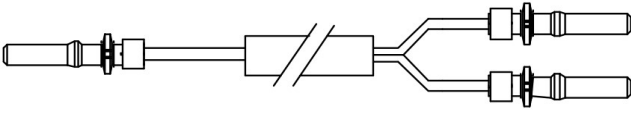
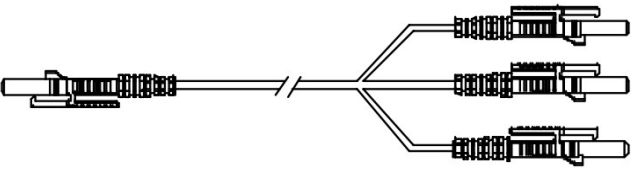
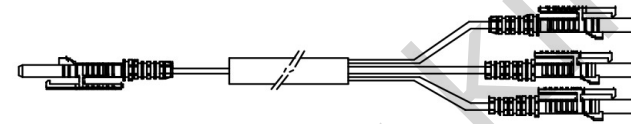
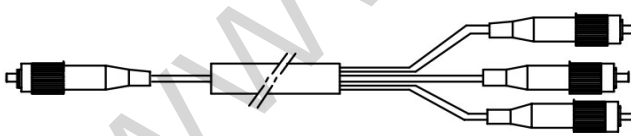
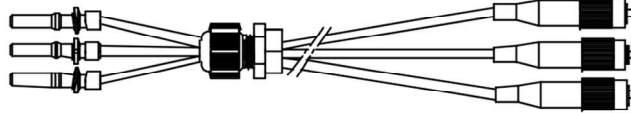



塑料光纤分路器1mm (POF) Plastic Fiber Splitter 1mm (POF)		
简图 /Dimension	描述 / Description	Art.-No.
	HFBR-4501-2 in 1 Plastic Fiber Splitter 2.2mm PE POF cable HFBR-4501-1分2 塑料光纤分路器 2.2mm PE POF光缆	KINZ-PC-Splitter005
	HFBR-4503/4513-3 in 1 Plastic Fiber Splitter 2.2mm PE POF cable HFBR-4503/4513-1分3 塑料光纤分路器 2.2mm PE POF光缆	KINZ-PC-Splitter006
	HFBR-4503/4513-3 in 1 Plastic Fiber Splitter 2.2mm PE POF cable HFBR-4503/4513-1分3 塑料光纤分路器 2.2mm PE POF光缆	KINZ-PC-Splitter007
	FC-FC-3 in 1 Plastic Fiber Splitter 2.2mm PE POF cable FC-FC- 1分3 塑料光纤分路器 2.2mm PE POF光缆	KINZ-PC-Splitter008
	4501_FC1000um -3 in 1 Plastic Fiber Splitter 2.2mm PE POF cable 4501_FC1000um-1分3 塑料光纤分路器 2.2mm PE POF光缆	KINZ-PC-Splitter009

*POF=Polymer fiber/*POF=聚合物光纤

All patch cord with dust cap/所有跳线带防尘帽

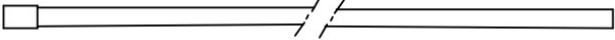
Can be further customized according to the requirements/可根据要求进行进一步定制

**Assembled
 POF Cables/
 组装POF光缆**

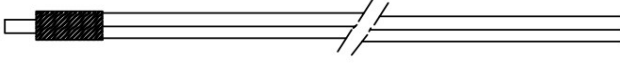

Plastic Fiber sensor (POF) 塑料光纤传感 (POF)		
简图 /Dimension	描述 / Description	Art.-No.
	Single -core with PE POF black cable 单芯带PE POF黑色光缆	KINZ-PC-Sensor-01
	3mm large core diameter fiber with PE POF black cable 3mm大芯径纤维带PE POF黑色光缆	KINZ-PC-Sensor-02
	3mm+1mm combined fiber with PE POF black cable 3mm+1mm的纤维带PE POF黑色光缆	KINZ-PC-Sensor-03
	Simplex,Jumper wires for air defense detection equipment for the new coronavirus epidemic black cable 单工,新型冠状病毒流行的防空探测设备的跳线黑色光缆	KINZ-PC-Sensor-04
	Reflective FD-66 Dual Core with PE POF black cable 带有PE POF的反射形FD-66双芯黑色光缆	KINZ-PC-Sensor-05
	Panasonic Mitsubishi 16 cores with PE POF black cable 松下三菱16芯带PE POF黑色光缆	KINZ-PC-Sensor-06

*POF=Polymer fiber/*POF=聚合物光纤

All patch cord with dust cap/所有跳线带防尘帽

Can be further customized according to the requirements/可根据要求进行进一步定制

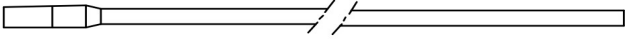
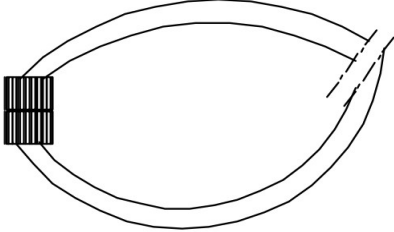
**Assembled
 POF Cables/
 组装POF光缆**

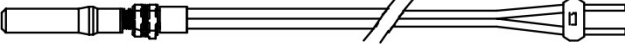
Plastic Fiber sensor (POF) 塑料光纤传感 (POF)		
简图 /Dimension	描述 / Description	Art.-No.
	Multi -core with PE POF black cable 多芯带PE POF黑色光缆	KINZ-PC-Sensor-07
	Eyencefu-35FA sensor patch cord with PE POF black cable EyenceFU-35FA传感跳线带PE POF黑色光缆	KINZ-PC-Sensor-08
	Reflective FD-45G-8 cores with PE POF black cable 带有PE POF的反射形FD-45G-8芯黑色光缆	KINZ-PC-Sensor-09
	Through type FT-49 single core with PE POF black cable 透过型FT-49单芯带PE POF黑色光缆	KINZ-PC-Sensor-010
	Eyencefu-35FA sensor patch cord with PE POF black cable EyenceFU-35FA传感跳线带PE POF黑色光缆	KINZ-PC-Sensor-011

*POF=Polymer fiber/*POF=聚合物光纤

All patch cord with dust cap/所有跳线带防尘帽

Can be further customized according to the requirements/可根据要求进行进一步定制

Shen Zhen Kinz Optoelectric Technology Co., Ltd.

Fiberkinz
 "The POF Solutions Company"

Assembled
 POF Cables/
 组装POF光缆

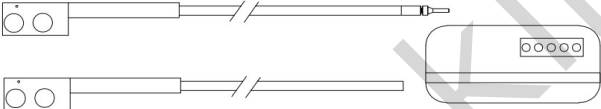



Plastic Fiber sensor (POF) 塑料光纤传感 (POF)		
简图 /Dimension	描述 / Description	Art.-No.
	Duplex,Back ring fiber with PE POF black cable 双工,回环光纤带PE POF黑色光缆	KINZ-PC-Sensor-012
	E32-T25ZR with PE POF black cable 带有PE POF电缆的E32-T25ZR黑色光缆	KINZ-PC-sensor-013

*POF=Polymer fiber/*POF=聚合物光纤

All patch cord with dust cap/所有跳线带防尘帽

Can be further customized according to the requirements/可根据要求进行进一步定制

**Assembled POF
 Cables/组装POF
 光缆**



Plastic Fiber 1mm (POF) 塑料光纤1mm (POF)		
简图 /Dimension	描述 / Description	Art.-No.
	LBB 4416/00 100 Install network cable with PE POF black cable LBB 4416/00 100安装网络电缆带PE POF 黑色光缆	KINZ-PC-Oth-01
	Kato Crane Cable With PE Pof Orange Cable 带PE POF橙色光缆的加藤吊车线缆	KINZ-PC-Oth-02
	Xiangguang customized fiber,with 1.0x 2.2mm PE POF black cable 翔光定制款光纤 1.0x 2.2mm POF 白色光缆	KINZ-PC-Oth-03
	Car connector,Simplex,with 1.0x 2.2mm PE POF black cable 汽车连接器，单工，1.0x 2.2mm PE POF 白色光缆	KINZ-PC-Oth-04

*POF=Polymer fiber/*POF=聚合物光纤

All patch cord with dust cap/所有跳线带防尘帽

Can be further customized according to the requirements/可根据要求进行进一步定制

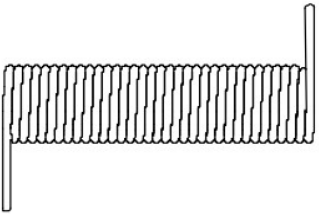
**Assembled POF
 Cables/组装POF
 光缆**





Plastic Fiber 1mm (POF) 塑料光纤1mm (POF)		
简图 /Dimension	描述 / Description	Art.-No.
	Slingshot fiber, Simplex, with 1.0x 2.2mm PE POF black cable 弹弓光纤, 单工, 1.0x 2.2mm PE POF 黑色光缆	KINZ-PC-Oth-05
	Multi-core (28 core) CK4.0 wind power generator lighting fiber Cable 多芯 (28芯) ck4.0风电发电机照明光纤	KINZ-PC-Oth-06
	Assembly cable 1X4 fibers, with PE POF black cable 组装1x4纤维, 带有PE POF黑色电缆	KINZ-PC-Oth-07

*POF=Polymer fiber/*POF=聚合物光纤

All patch cord with dust cap/所有跳线带防尘帽

Can be further customized according to the requirements/可根据要求进行进一步定制

**Assembled FO
 Cables/组装PO
 光缆**

Glass Optical Fiber Patch Cord 玻璃光纤跳线		
简图 /Dimension	描述 / Description	Art.-No.
	Glass fiber patch cord 玻璃光纤跳线	
	LC-SC yellow single-mode fiber optic cable LC-SC黄色单模光纤跳线	KINZ-PC-Glass-01
	LC-SC industrial-grade multi-mode fiber optic cable, Orange LC-SC工业级多模光纤跳线橙色	KINZ-PC-Glass-02
	FC/APC-E2000/APC/SX/MM/50/3.0/10M Glass fiber optic cable, Orange FC/APC-E2000/APC/SX/MM/50/3.0/10M 玻璃光纤跳线橙色	KINZ-PC-Glass-03
	SC-SC multi-mode quartz fiber optic cable, Orange SC-SC多模石英光纤跳线橙色	KINZ-PC-Glass-04
	SC-SC dual, single-mode glass fiber yellow SC-SC双工单模玻璃光纤黄色	KINZ-PC-Glass-05
	SC-SC optical fiber jump glass optical fiber, Orange SC-SC光纤跳线橙色玻璃光纤	KINZ-PC-Glass-06

*Glass fiber=玻璃光纤



All patch cord with dust cap/所有跳线带防尘帽

Can be further customized according to the requirements/可根据要求进行进一步定制

Shen Zhen Kinz Optoelectric Technology Co., Ltd.

Fiberkinz
 “The POF Solutions Company”

Assembled FO
 Cables/组装PO
 光缆





Glass Optical Fiber Patch Cord 玻璃光纤跳线		
简图 /Dimension	描述 / Description	Art.-No.
	Multi-mode,dual-core,duplex-LC/UPC- LC/UPC-2.0mm -M3-LSZH-3-meter-water blue 多模双芯双工-LC/UPC-LC/UPC-2.0mm- OM3-LSZH-3米-水蓝色	KINZ-PC-Glass-07
	Multi-mode,dual-core,duplex-LC/UPC- LC/UPC-3.0mm -M3-LSZH-3-meter-water blue 多模双芯双工-LC/UPC-LC/UPC-3.0mm- OM3-LSZH-3米-水蓝色	KINZ-PC-Glass-08
	QG-G50-2C-17M-B-LL/QJ71GP21-SX model/Mitsubishi PLC servo fiber cable QG-G50-2C-17M-B-LL/QJ71GP21-SX模/ 三菱PLC伺服光纤	KINZ-PC-Glass-09

*Glass fiber=玻璃光纤

All patch cord with dust cap/所有跳线带防尘帽

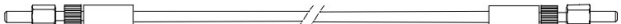
Can be further customized according to the requirements/可根据要求进行进一步定制

**Assembled
 Laser Cables/组
 装激光光缆**



Laser Fiber (Energy Fiber & Medical Fiber) 激光光纤 (能量光纤&医疗光纤)		
简图 /Dimension	描述 / Description	Art.-No.
能量光纤&医疗光纤		
	D80-D80,1500UM with coating 755nm, NA0.37 for 755 nm 1064 lasers,PVC+Metal Cable D80-D80,1500UM, 涂层755nm, NA0.37 for 755 nm 1064激光器, PVC+金 属光缆	KINZ-PC-Energy-01
	SMA905-200UM,200/300/600UM Medical fiber cable,Orange SMA905-200UM,200/300/600UM 医疗光 纤橙色	KINZ-PC-Energy-02
	Sma905-Sma905,1000/1100/1350/1800um Quartz fiber patch cord Sma905-Sma905,1000/1100/1350/1800um 石英光纤跳线	KINZ-PC-Energy-03
	SMA905-2000um,Fluorescent fiber POF pigtail SMA905-2000um,荧光光纤尾鞭	KINZ-PC-Energy-04

*Energy Fiber & Medical Fiber

所有跳线带防尘帽/All patch cord with dust cap

可根据要求进行进一步定制/Can be further customized according to the requirements

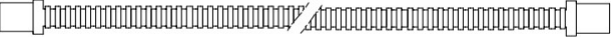
**Assembled
 Laser Cables/组
 装激光光缆**

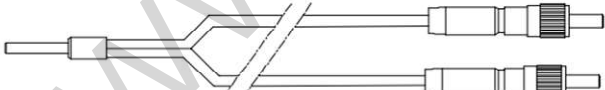
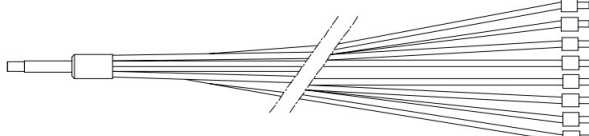

Laser Fiber (Energy Fiber & Medical Fiber) 激光光纤 (能量光纤&医疗光纤)		
简图 /Dimension	描述 / Description	Art.-No.
	SIH200 ST/PC-ST/PC 6.0MM ,200/220 Wavelength 400-2200nm,medical fiber cable SIH200 ST/PC-ST/PC 6.0MM ,200/220 波 长 400-2200nm, 医疗光纤	KINZ-PC-Energy-05
	High -temperature fire test fiber patch cord, medical optical fiber 高温火检光纤跳线, 医疗光纤	KINZ-PC-Energy-06
	Freckle fiber, medical optical fiber 祛斑光纤,医疗光纤	KINZ-PC-Energy-07
	Sma905,Transmitted intrusion fiber optic cable, medical optical fiber 透射侵入式光纤光缆,医疗光纤	KINZ-PC-Energy-08
	Sma905,Transmitted intrusion fiber cable, medical fiber 透射侵入式光纤跳线,医疗光纤	KINZ-PC-Energy-09
	Customized fiber image optical fiber beam museum lighting fiber Glass fiber beam multi -core fiber beam 定制光纤 图像光纤束 博物馆照明光纤 玻璃光纤束 多芯光纤束	KINZ-PC-Energy-010

*Energy Fiber & Medical Fiber

所有跳线带防尘帽/All patch cord with dust cap

可根据要求进行进一步定制/Can be further customized according to the requirements

**Assembled
 Laser Cables/组
 装激光光缆**

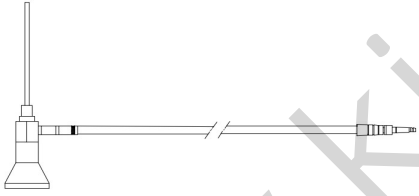
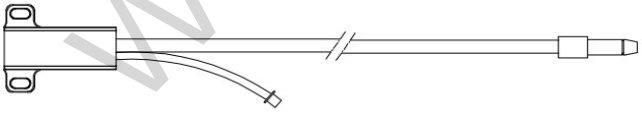
Laser Fiber (Energy Fiber & Medical Fiber) 激光光纤（能量光纤&医疗光纤）		
简图 /Dimension	描述 / Description	Art.-No.
	Sma905, Holmium laser fiber 275μm, 365μm, 550μm, 800μm, 1000μm SMA905, H软激光光纤 275μm, 365μm, 550μm, 800μm, 1000μm	KINZ-PC-Energy-011
	D80-D80, welding laser, cutting, marking, cleaning fiber patch cord, green D80-D80,焊接激光,切割,打标,清洗光纤跳线,Green	KINZ-PC-Energy-012
	Medical endoscopic optical fiber patch cord 医疗内窥镜光纤跳线	KINZ-PC-Energy-013
	spectrometer fiber optical cable 6 core +1 core 光谱仪线6芯+1芯	KINZ-PC-Energy-014
	spectrometer fiber optical cable 7 core +1 core 光谱仪线7芯+1芯	KINZ-PC-Energy-015

*Energy Fiber & Medical Fiber

所有跳线带防尘帽/All patch cord with dust cap

可根据要求进行进一步定制/Can be further customized according to the requirements